

Cours de Thermique du bâtiment

Vidéo n°5

Rayonnement 2 : échanges radiatifs GLO

Simon Rouchier
Maître de Conférences
Polytech Anancy-Chambéry
Université de Savoie

vidéo réalisée le 15/10/2015



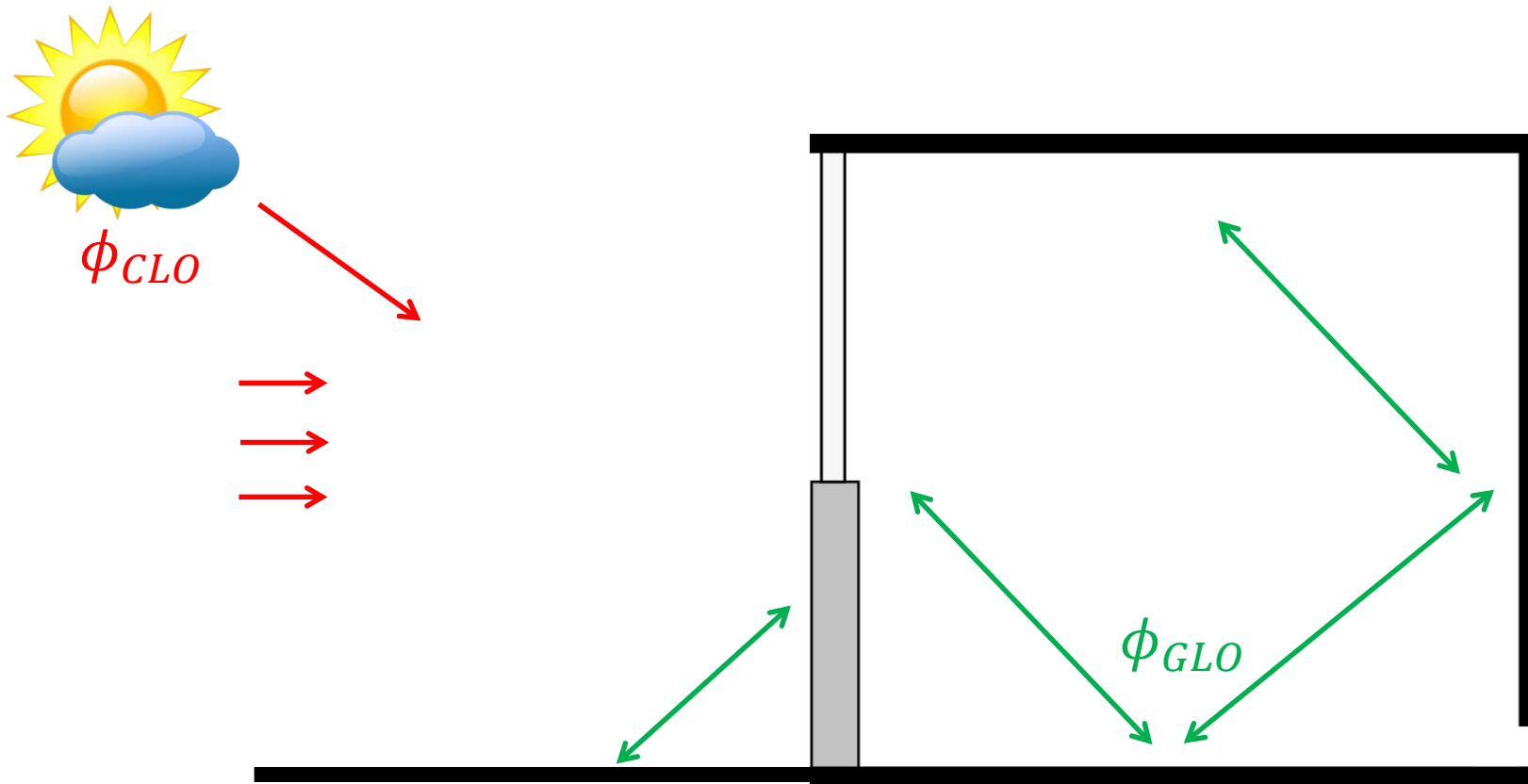

$$J = \varepsilon M^0 + \rho E$$

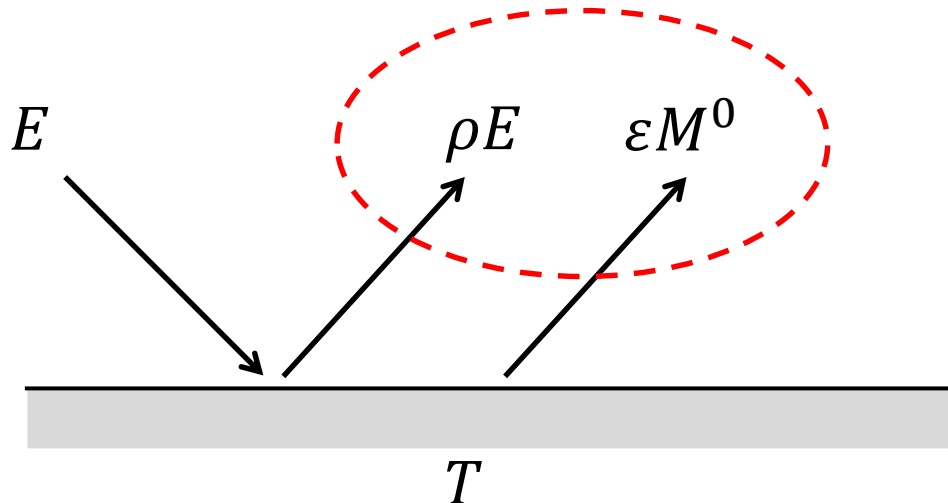

avec $M^0 = \sigma T^4$

E Eclairement incident

M^0 Emittance de corps noir [W/m²]

J Radiosité

ρ Réflectivité [-]

ε Emissivité



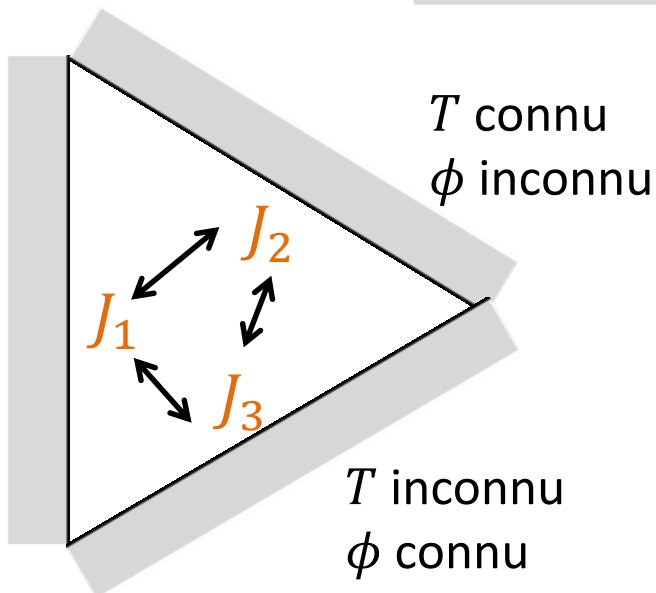
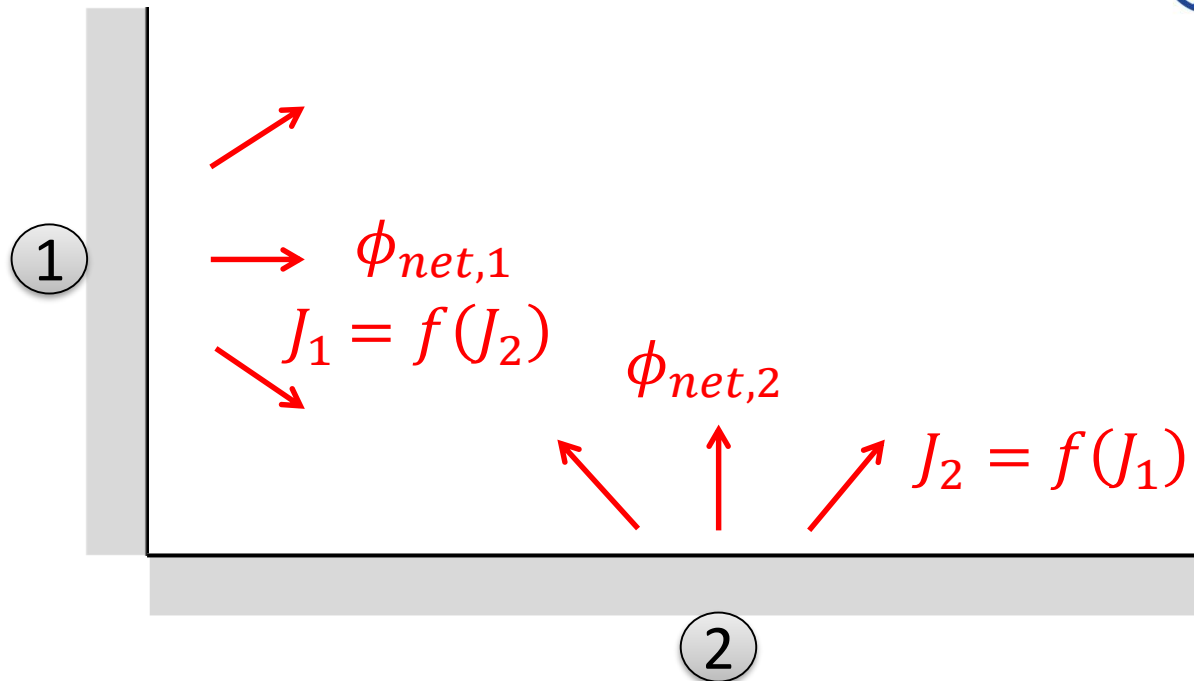

$$\phi_{net,i} = S_i \frac{\epsilon_i}{1 - \epsilon_i} (\sigma T_i^4 - J_i)$$

$$\phi_{net,i} = \sum_j \frac{J_i - J_j}{\left(\frac{1}{S_i F_{ij}} \right)}$$



$$\phi_{net,i} = S_i \frac{\epsilon_i}{1 - \epsilon_i} (\sigma T_i^4 - J_i)$$

$$\phi_{net,i} = \sum_{j \neq i} \frac{J_i - J_j}{\left(\frac{1}{S_i F_{ij}} \right)}$$

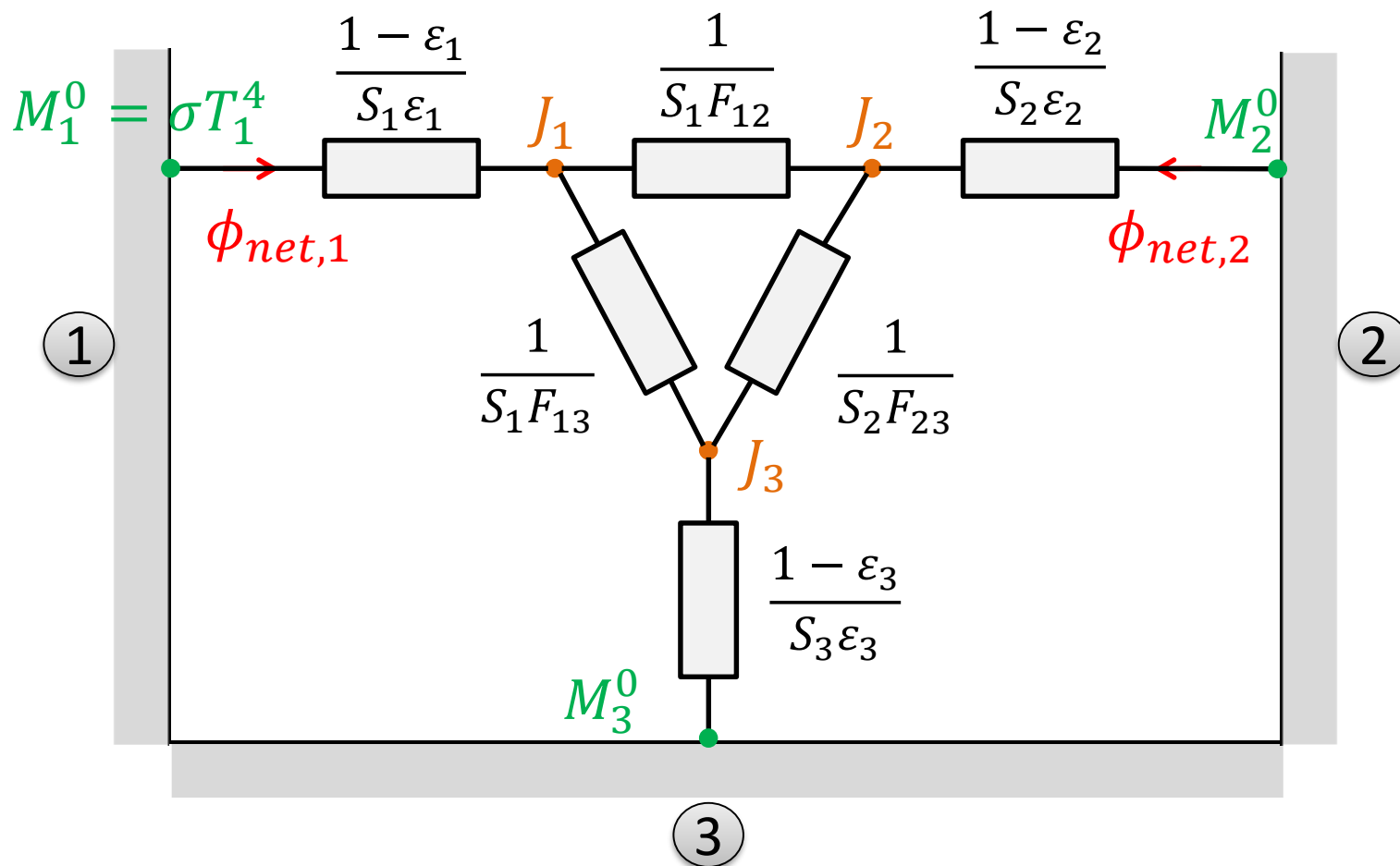

T connu
 ϕ inconnu

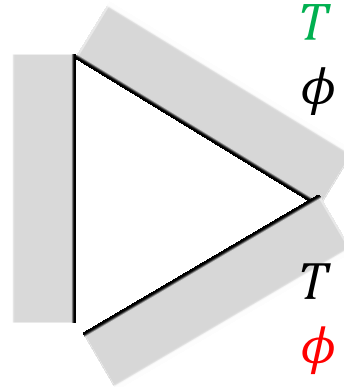

T connu
 ϕ inconnu

T inconnu
 ϕ connu

1. Pour chaque surface, le flux net ou la température est connue

2. Calculer les facteurs de forme

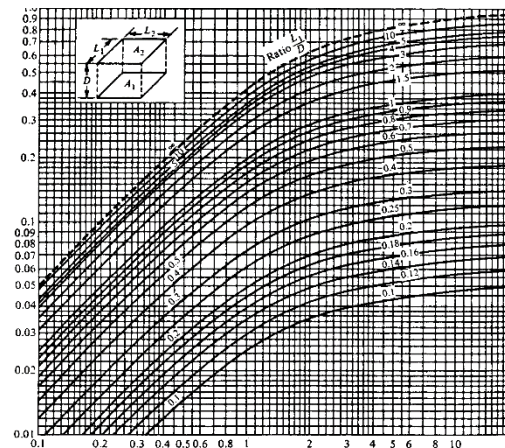

$$S_1 F_{12} = S_2 F_{21}$$

$$\sum_j F_{ij} = 1$$

3. Calculer les radiosités

$$\begin{bmatrix} 1 - (1 - \varepsilon_1)F_{11} & -(1 - \varepsilon_1)F_{12} & -(1 - \varepsilon_1)F_{13} \\ -(1 - \varepsilon_2)F_{21} & 1 - (1 - \varepsilon_2)F_{22} & -(1 - \varepsilon_2)F_{23} \\ -F_{31} & -F_{32} & 1 - F_{33} \end{bmatrix} \cdot \begin{bmatrix} J_1 \\ J_2 \\ J_3 \end{bmatrix} = \begin{bmatrix} \varepsilon_1 \sigma T_1^4 \\ \varepsilon_2 \sigma T_2^4 \\ 0 \end{bmatrix}$$

4. En déduire les températures et flux inconnus





Température radiante moyenne

$$T_{rm} = \left(\sum_i \frac{F_{Si} J_i}{\sigma} \right)^{1/4}$$

Version simplifiée

$$\sum_i \phi_{net,i} = 0$$

avec

$$\phi_{net,i} \approx h_{ri} S_i (T_i - T_{rm})$$

avec

$$h_{ri} = 4\varepsilon_i \sigma T_i^3$$

démonstration

F_{ij} simplifiés

$$\phi_{net,i} = \sigma \varepsilon S (T_i^4 - T_{rm}^4)$$

$$T_i^4 - T_{rm}^4 = 4 \cdot T_i^3 (T_i - T_{rm})$$

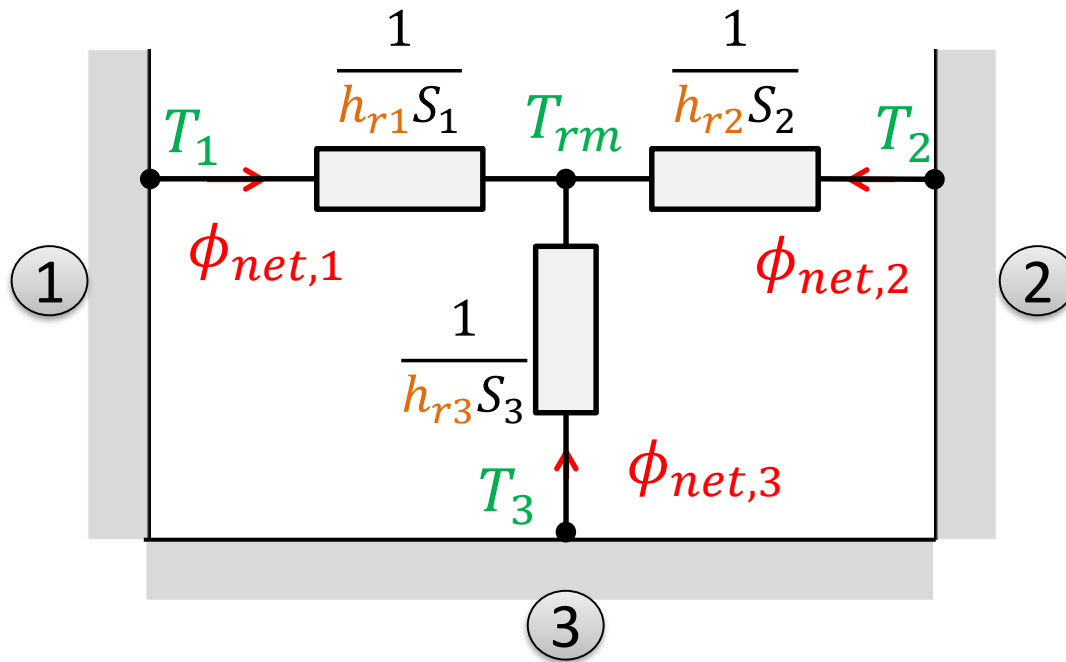

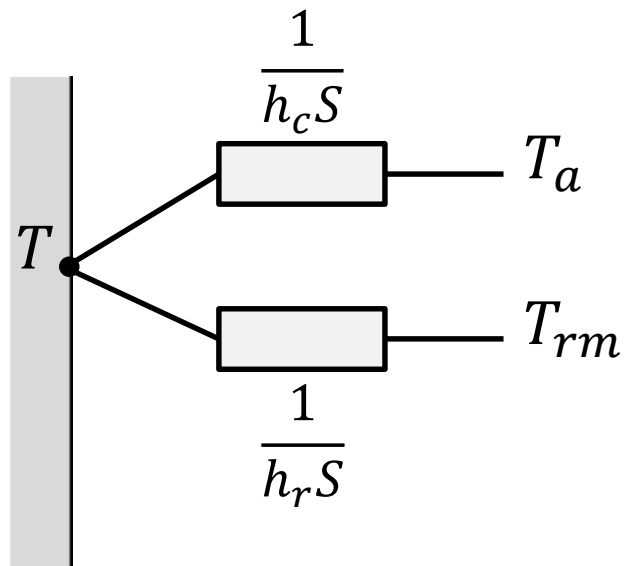

Température résultante

$$T_{rs} = \frac{h_c T_a + h_r T_{rm}}{h_c + h_r}$$

